

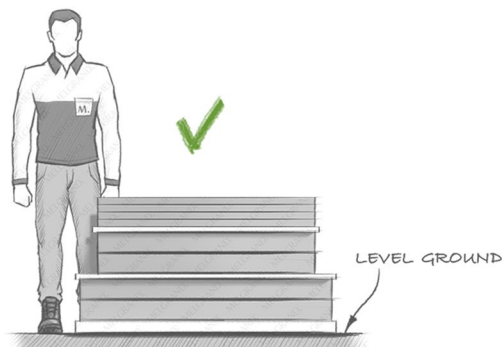

MELGRAND.

CUSTOMER HANDLING AND STORAGE OF MELGRAND FAÇADE MOULDINGS

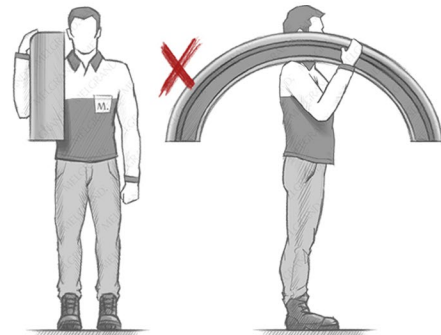
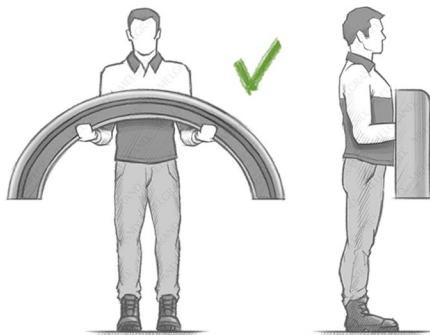
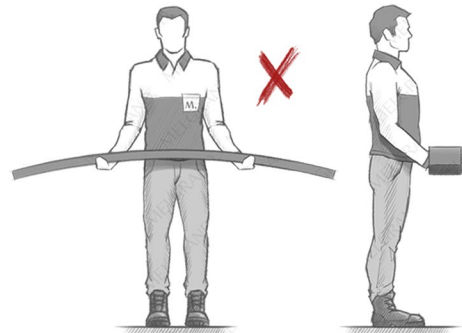
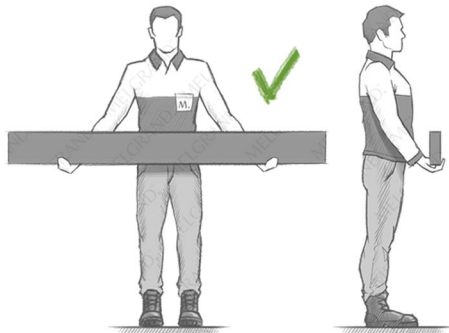
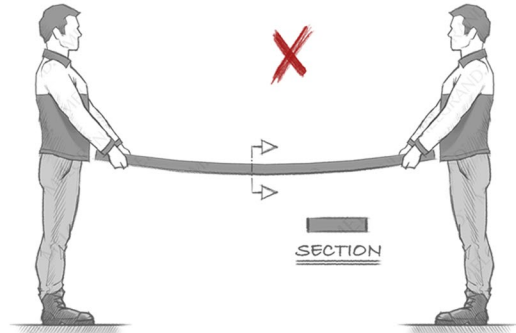
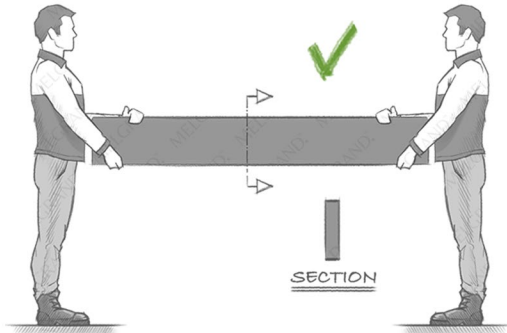

Our mouldings can be fragile: handle with care. Please examine the illustrations on this page and follow the directions for lifting and moving MELGRAND mouldings. Uncontrolled flex of some mouldings can result in a fracture. Always carry mouldings in the correct way to minimise flex; that is side-on, not flat, as shown in the illustrations.

If carrying in the flat orientation, provide support for the middle of the piece. Arrange for a second person to share the weight, carefully reducing the flex. Do not install an element with visible fractures and seek advice from MELGRAND Customer Service. Our mouldings are to be stored in a dry, undercover environment laying flat on level ground.

V2.2021

ADDRESS

VIC 6-8 Anderson Road, Thornbury 3071
NSW 6/376 Newbridge Rd, Moorebank 2170

CONTACT

1300 663 118
Fax 1300 676 233
sales@melgrand.com.au